

SUMTOR

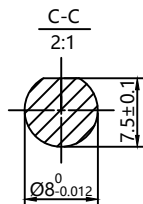
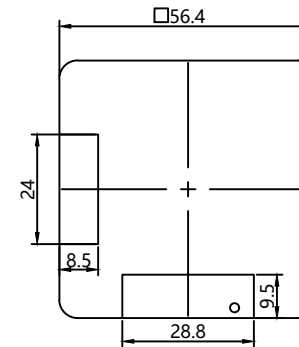
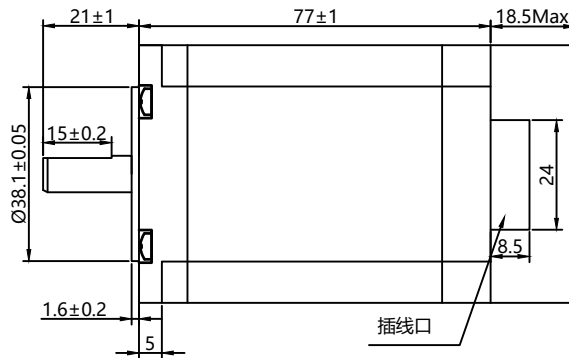
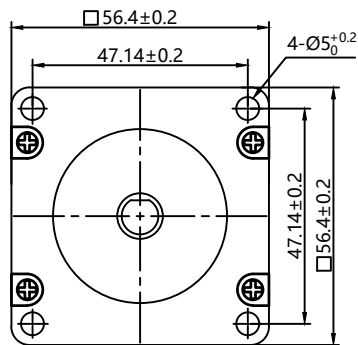

Electrical Specifications			
PHASE	相数	2	PHASE
STEP ANGLE	步距角	1.8 ° /STEP	
RATED VOLTAGE	相电压	1.6 V	
CURRENT	相电流	4.0 A	
RESISTANCE	相电阻	0.4 Ω	
INDUCTANCE	相电感	1.6 mH	
HOLDING TORQUE	静力矩	2.0 NM	
DETENT TORQUE	定位力矩	75 mNm	
ROTOR INERTIA	转动惯量	480 g.cm <sup>2</sup>	
MOTOR LENGTH	机身长度	95.5 mm	

pulse/rev	SW3	SW4	SW5	SW6
400	ON	ON	ON	ON
800	OFF	ON	ON	ON
1600	ON	OFF	ON	ON
3200	OFF	OFF	ON	ON
6400	ON	ON	OFF	ON
12800	OFF	ON	OFF	ON
25600	ON	OFF	OFF	ON
51200	OFF	OFF	OFF	ON
1000	ON	ON	ON	OFF
2000	OFF	ON	ON	OFF
4000	ON	OFF	ON	OFF
5000	OFF	OFF	ON	OFF
8000	ON	ON	OFF	OFF
10000	OFF	ON	OFF	OFF
20000	ON	OFF	OFF	OFF
40000	OFF	OFF	OFF	OFF
Direction Set	SW1=OFF CW SW1=ON CCW			
Output Current	SW2=OFF Imin1.0A Imax3.5A SW2=ON Imin1.0A Imax4.2A			

DC12-50V

GND

DC+

PU+ PU-

DR+ DR-

EN+ EN-

AM+ AM-

A B

A B

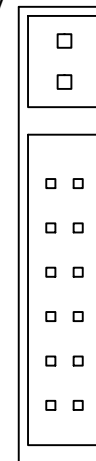

接线示意图

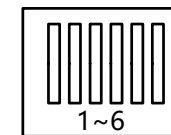

序号	数量	名称/代号/材料		
设计		审核	日期	比例
张百灵		邹志仁	2023/3/1	1:1
无锡三拓电气设备有限公司 SUMTOR(Wuxi) Electric CO.,Ltd		57HS76ESI		
项目	57开环一体机	图号	57HS	版本 V2.0