

SUMTOR

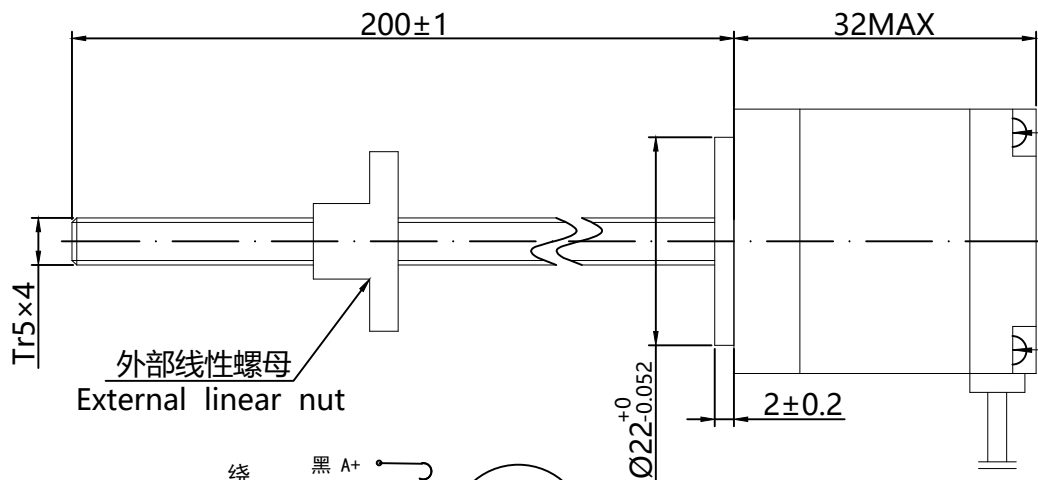

绕组接线图

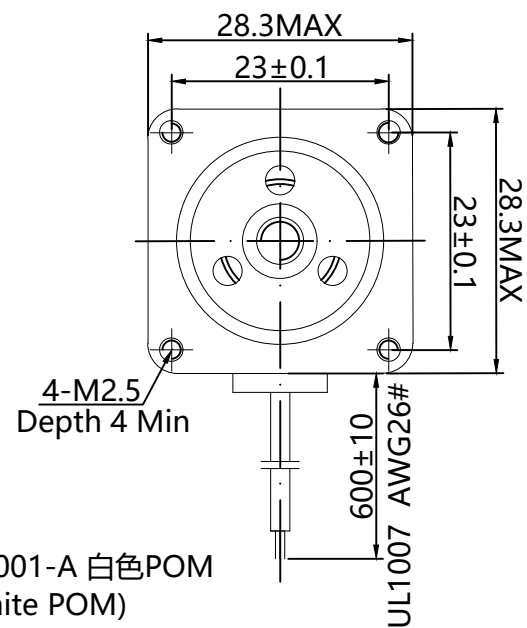
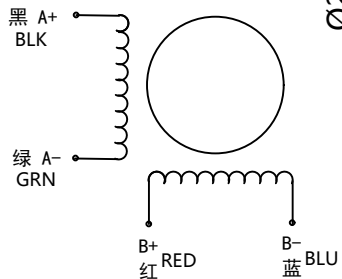

MR001-A 白色POM
(White POM)

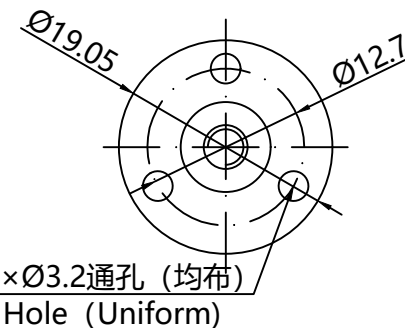
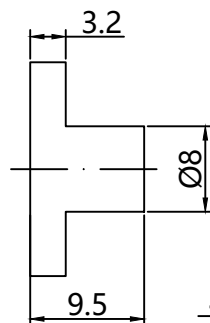

外形尺寸: unit=mm

Electrical Specifications			COMMENT	螺杆规格	
				The screw shaft specifications	
STEP ANGLE	步距角	1.8 ° /STEP		规格Modle	Tr5×4
RATED VOLTAGE	相电压	2.9 V		步长Resolution	0.02mm
CURRENT	相电流	0.67 A/PHASE		导程Lead	4
RESISTANCE	相电阻	4.3 Ω /PHASE		螺距Screw head	1
INDUCTANCE	相电感	2.8 mH/PHASE		型号Nut NO:	WCC
HOLDING TORQUE	静力矩	6 N.cm			
DETENT TORQUE	定位力矩	50 g.cm			
ROTOR INERTIA	转动惯量	9 g.cm ²			
MOTOR WEIGHT	重量	160 g			

序号	数量	名称/代号/材料			
设计	审核	批准	日期	图号	比例
邹志仁					1:1
无锡三拓电气设备有限公司 SUMTOR(Wuxi) Electric CO.,Ltd			28HZ3306T5C4-200		
项目			版本	V1.0	